

CZ Dětský zahradní domek velký • návod na montáž



PINIE Lubná, spol. s r.o.

CZ-270 36 Lubná 250, Czech republic

Tel.: +420 777 708 071

E-mail: info@pinie.cz

Finie[®]
www.pinie.cz



Rozměry: 1850 x 1220 x 1260 mm

Materiál: Durelis / OSB / Překližka foliovaná

Domeček doporučujeme ošetřit dvěma vrstvami voděodolného nátěru. Po zaschnutí první vrstvy domek mírně přebruste (hr. 100 nebo 120) a poté naneste druhou vrstvu.

Domeček umístěte na suchý a pevný podklad (např. zámková dlažba). Pro ještě delší životnost domečku doporučujeme na jeho střechu připevnit krytinu (např. „asfaltové“ šindele).

Příbalený spojovací materiál:

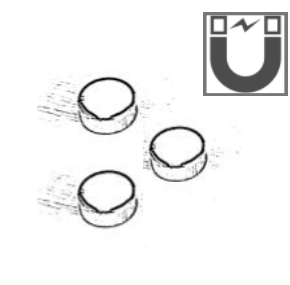
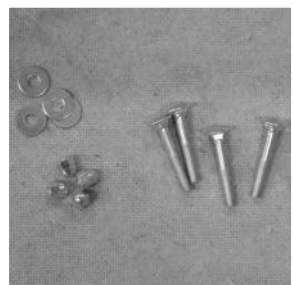
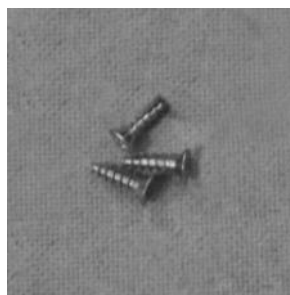
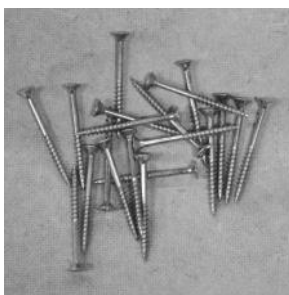

1

x3

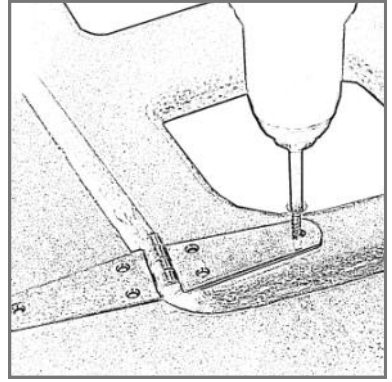
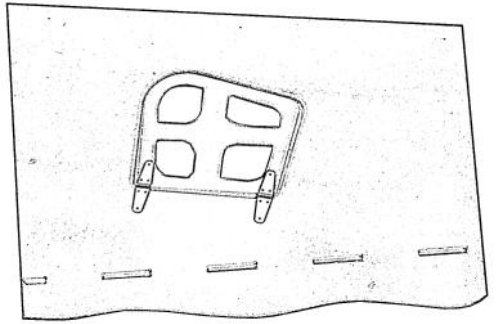
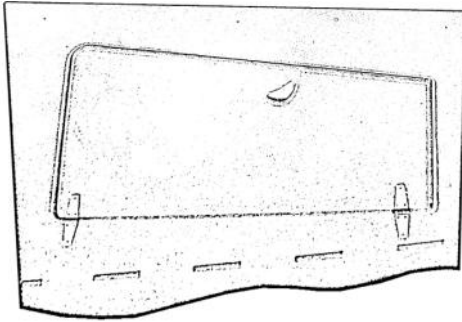

2

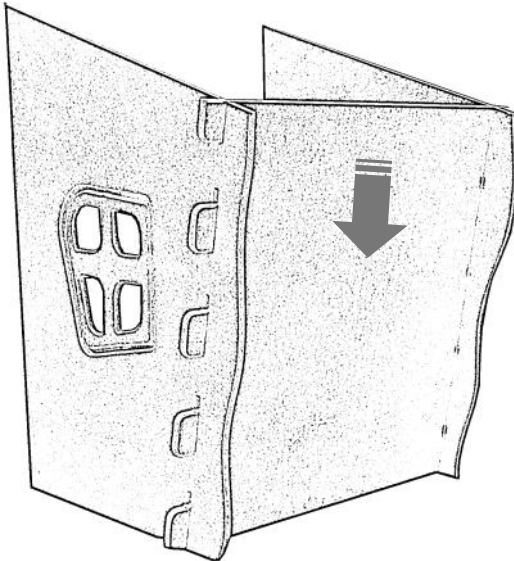

x2

3

2

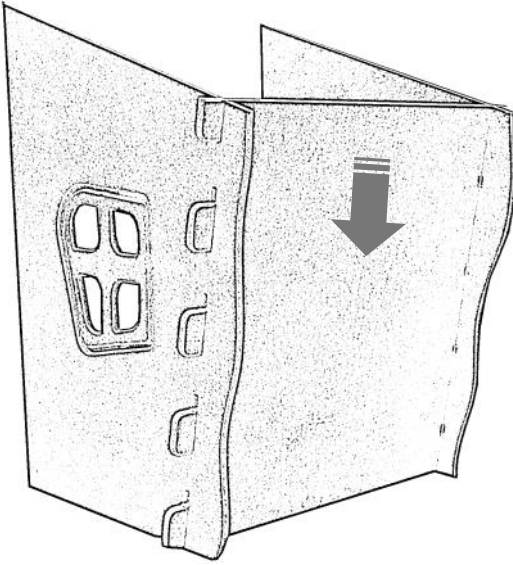

x2

3

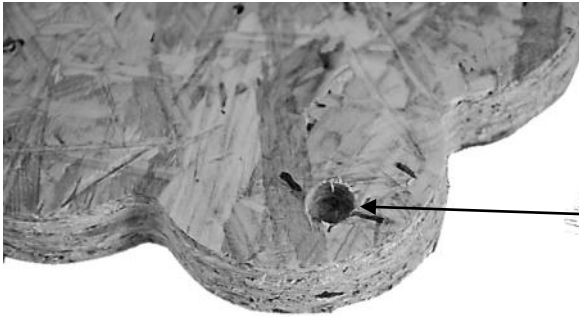

4

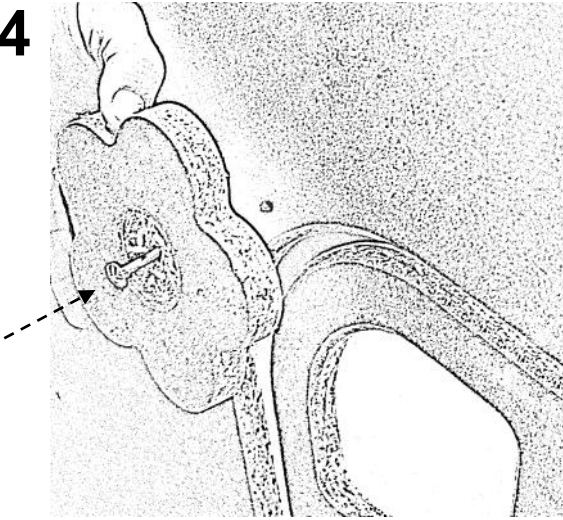

5

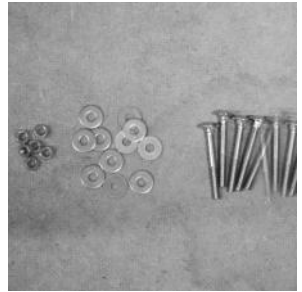
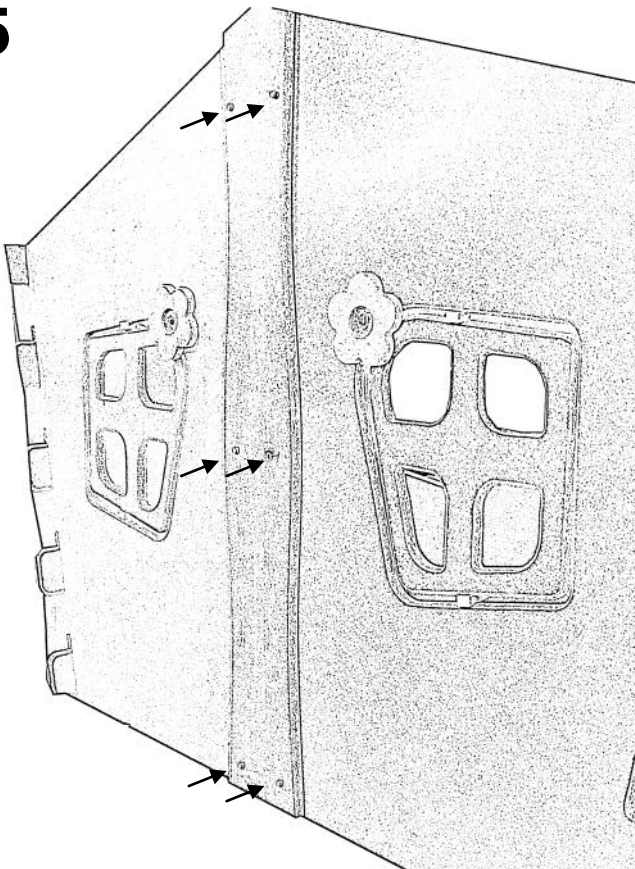

x2

6

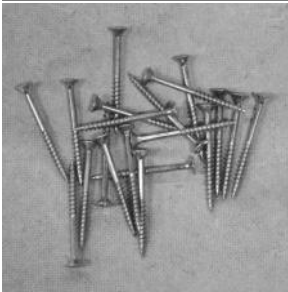
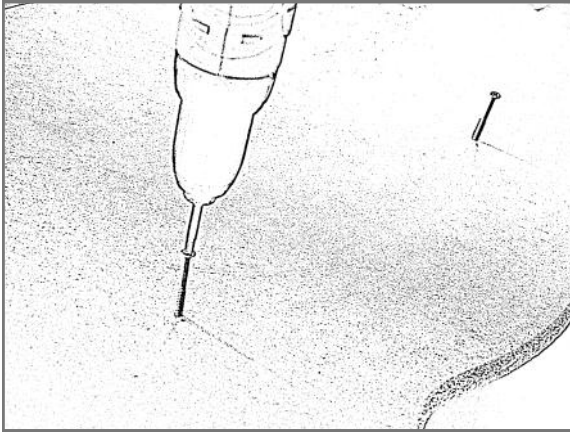
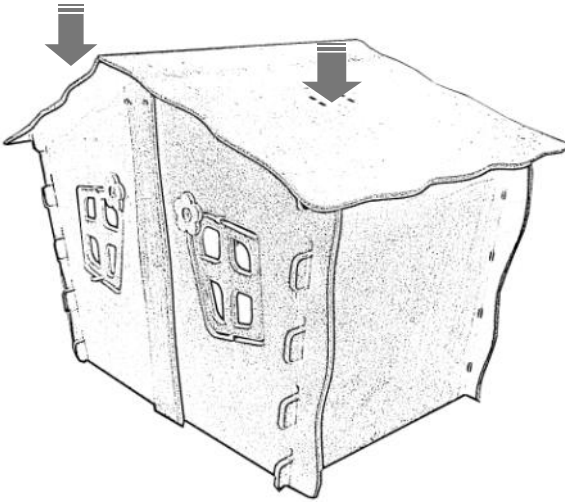

7

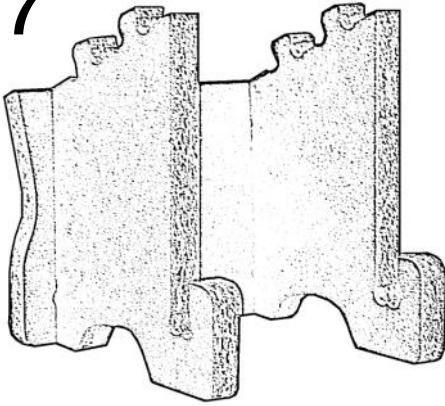

8

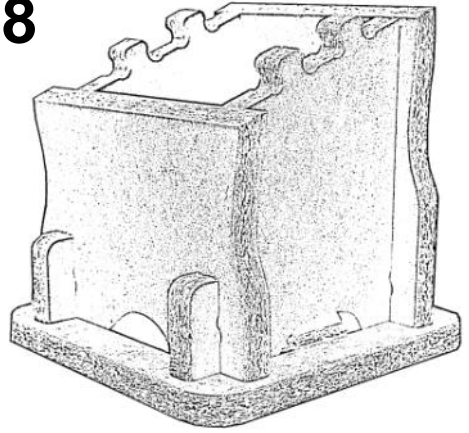

9

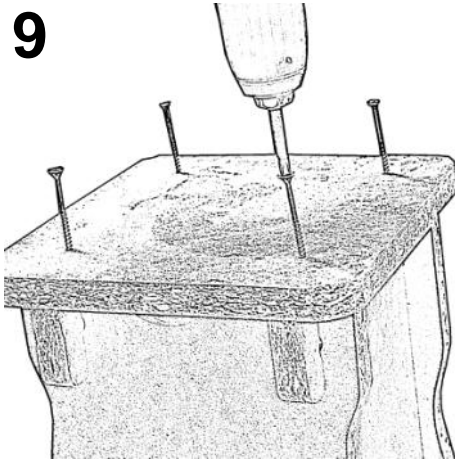

10

